

Capability Statement – Minerals business unit

ANSTO's Minerals business unit consists of a team of 60+ professionals and technicians with expertise that covers chemical engineering, metallurgy, mineralogy, chemistry, geology and radiation safety.

We provide process development services, technical review and consulting services, as well as collaborative and contract research in a number of areas:

- Uranium Ore Processing
- Rare Earth Processing
- Base Metal Processing
- Speciality Metals Processing
- Radioactivity Control and Management
- Novel Flowsheet Design, Modelling and Concept Level Engineering.

We have a 40-year track record of providing practical solutions and innovative technology in ways that deliver financial and environmental benefits to the mining and minerals processing industries. In Figure I is shown an overview of ANSTO's minerals activities across a range of industries. Short biographies of our key staff in each of these areas are provided at the end of this document.

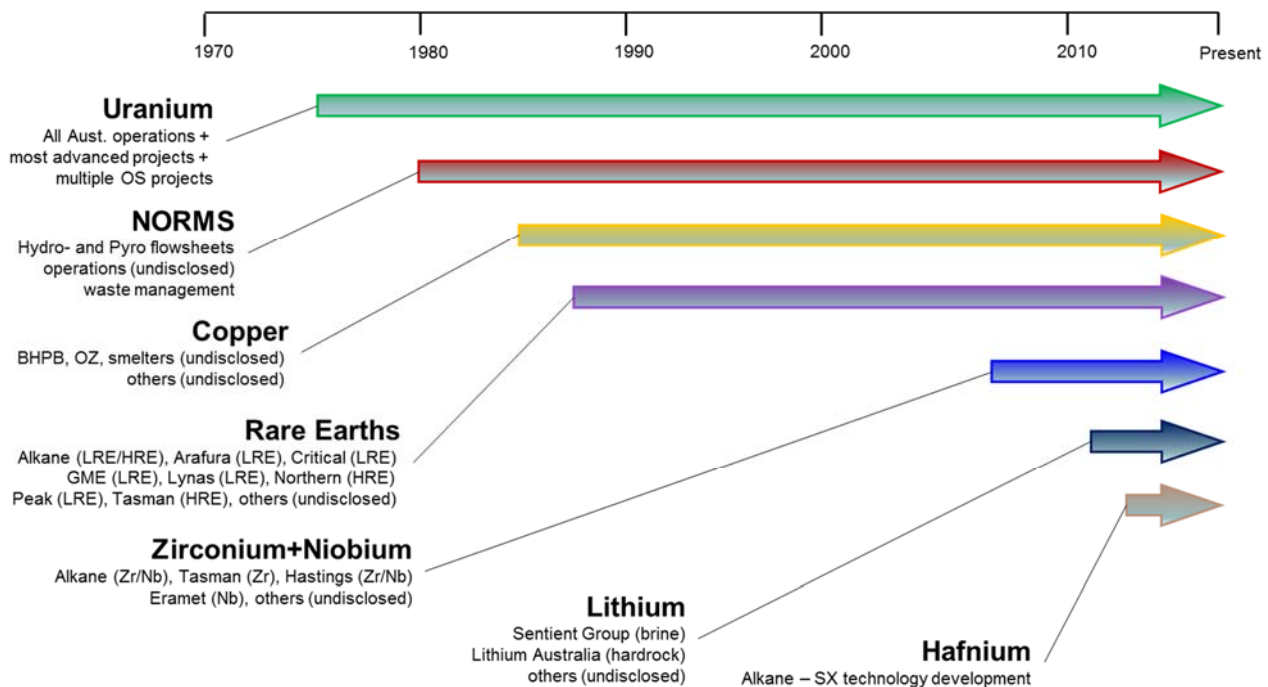

Figure I An Overview of ANSTO's Minerals Industrial Experience

Capability Statement – Minerals business unit

Uranium Ore Processing

ANSTO is the leading process development facility in Australia for expertise in the leaching and processing of uranium ores, and has been active in the development and application of technology for the uranium industry for over 35 years. Our project work has included all facets of the uranium flowsheet, including leaching (acid and alkaline, heap and in-situ), solvent extraction (SX), ion exchange (IX), Resin-In-Pulp (RIP), uranium product precipitation, impurity control (including radioactivity) and process water treatment, including nanofiltration (NF) and reverse osmosis (RO).

Various images of equipment employed for uranium ore processing, and continuous piloting undertaken by the Minerals business unit are presented in Appendix A. This equipment is typically capable of processing up to 10s' kg/h or up to 100s' L/h depending on the process flowsheet.

We have carried out studies for all of Australia's operating sites, MKU, Nabarlek, Olympic Dam, Ranger, Beverley, Honeymoon and Four Mile and undertaken development work for Jabiluka, Koongarra, Mt Gee, Kintyre, Crocker Well, Westmoreland, Yeelirrie, Lake Way, Wiluna, Valhalla, Anderson's Lode, Samphire, Bigryli, Mulga Rock, Bennett Well and Honeymoon (restart).

We have had continuous involvement with Australia's major operations, Ranger and Olympic Dam, since start-up.

Site work, including surveys, audits and plant trials, has been an important feature of our involvement with industry, and plant operations have continued to be a significant factor in transferring the results of our laboratory research to industry. We have carried out site work for all of Australia's past uranium operations. More recently, ANSTO has been involved with overseas projects related to the Rossing and Langer Heinrich operations and the Trekkopje, Husab and Marenica deposits in Namibia, the Mkuju River and Likuyu North deposits in Tanzania, the Kayelekera operation in Malawi, the Falea deposit in Mali, the Lumwana project in Zambia, as well as developing projects in Sweden, Spain, Mauritania and Canada. Site work has been undertaken at Langer Heinrich and Rossing in Namibia.

The work conducted at ANSTO has directly supported several NI 43-101 reports, and numerous preliminary, definitive and bankable feasibility studies.

Rare Earth Processing

The Minerals business unit has extensive experience in rare earth process development, all the way through to separated final products. We have several rare earth experts in our team, with almost 30 years of experience, dating back to our early work on the Mt Weld deposit (monazite mineralogy) in the early 1990s. Over the last ~10 years, we have worked on numerous rare earth projects both in terms of process development and providing expert advice.

Following laboratory process development studies by our group, fully integrated pilot plants have been operated for the Mt Weld (Lynas), Nolans (Arafura) and Toongi/Dubbo (AZL) rare earth projects at ANSTO. We have also undertaken extensive process development studies for Peak Resources on their Ngualla (bastnasite mineralogy) project in Tanzania, for Northern Minerals on their Brown's Range (xenotime mineralogy) project in Australia, and Tasman Minerals (eudialyte mineralogy), Rare Element Resources (bastnasite) and several other companies seeking to progress rare earth projects, some of which involve the processing of monazite.

Capability Statement – Minerals business unit

Our project work has included all facets of rare earth processing including acid leaching, sulphation baking, caustic conversion, alkaline roasting, selective precipitation, impurity removal, solvent extraction, ion exchange, and process water treatment (softening). We have been responsible for continuous pilot plant demonstration from ore / mineral concentrate to production of mixed chemical concentrate for the majority of these projects.

Various images of equipment employed for rare earth processing, including mixing and roasting equipment, continuous piloting and demonstration plants undertaken at ANSTO are presented in Appendix B. This equipment is typically capable of processing up to 10s' kg/h or up to 100s' L/h depending on the process flowsheet.

In addition to production of mixed rare earth chemical concentrates, we have produced a range of separated light rare earth oxide products (La, Ce, Nd, Nd / Pr) and mixed middle and mixed heavy rare earth concentrates by continuous operation of a multi-stage solvent extraction circuit. The product purities produced ranged from 99 (2N) to 99.9 (3N). Fully integrated pilot plants producing mixed rare earth oxalate and carbonate products have been operated for several projects.

The solvent extraction facility at ANSTO is one of the few facilities world-wide capable of separating the individual rare earths to this purity outside of China. This equipment has mixer and settler volumes ranging from 0.125–4.7 L and 0.45–20 L, respectively. Pulsed column equipment is also available.

The work conducted by our team has directly supported several NI 43-101 reports, and numerous preliminary, definitive and bankable feasibility studies.

Lithium Processing

Over the last 6 years, our group has undertaken a significant amount of work on the processing of lithium deposits to produce saleable lithium chemical concentrates. This work has encompassed everything from bench top process development through to continuous piloting (1–5 kg/h solid feed and 5-10 L/h liquor feed) and to demonstration plant design and operation (2 m³/h brine feed). These continuous operations and demonstration pilots have produced between 5–500 kg of battery grade lithium carbonate for product testing, refining and conversion to lithium hydroxide. This work has been conducted on brine, spodumene, Li-bearing micas and clay feedstock.

Various images of lithium process development, continuous piloting and demonstration plants undertaken by the Minerals business unit are presented in Appendix C.

Our hydrometallurgy experience gained from the processing of uranium, rare earths etc has allowed us to develop an alternative process to the traditional brine flowsheets adopted by SQM, FMC and Orocobre, which rivals that being pursued by POSCO on raw brine. This work has been conducted in collaboration with the Sentient Group for the Salar del Rincon deposit in Argentina.

Similarly, we are currently applying our knowledge and experience to develop a revolutionary approach for the processing of hardrock Li pegmatites for Lithium Australia, as well as an alternative process for the processing of spodumene, which is more energy efficient and cost effective than is currently practiced.

These efforts have directly supported several NI 43-101 reports and preliminary, definitive and bankable feasibility studies.

Capability Statement – Minerals business unit

Base Metal Processing

Within the Minerals business unit are numerous staff with an extensive range of experience with base metals processing (Cu, Co, Ni, Zn, Mn). This experience has been gained through the development of processes for both base metal sulphides and oxides, from minerals processing through to production of saleable metal products, including metals.

- Recovery of cobalt and nickel from nickel laterite and sulphides (via HPAL) processing, including high density sludge (HDS) for improving water balance
- Recovery of Cu, Co, Ni and Zn from sulphide concentrates by both pressure oxidation (POX) and atmospheric oxidative leaching, and from oxides via pressure and atmospheric leaching.

This experience encompasses all aspects of base metal treatment including leaching, impurity removal, solvent extraction, ion-exchange and electrowinning. Autoclave based programs have been conducted on equipment up to 2 L working capacity. Stainless steel, Inconel and titanium shells + wetted parts are available depending on the process conditions required.

Speciality Metals Processing

In addition to our long-standing involvement with all aspects of uranium and rare earth processing, we also have personnel with a vast range of industrial experience encompassing mineral processing and hydrometallurgical and pyrometallurgical processing of speciality and rare metals (Zr, Nb, Ti, V, Mo, W, Sc, Au and Ag).

This experience has been gained through development of processes for recovery of such elements as by-products of uranium (V, Mo, Au and Ag) and rare earth processing (Sc), as well as processes focused only on recovery of these elements. Some specific examples include the following:

- Extensive process development and pilot scale development targeting niobium, zirconium and hafnium for the Toongi/Dubbo (AZL) rare earth project. The work conducted on the recovery of niobium involved selective precipitation through purification to ferro-niobium production. An enormous breadth of work has been conducted for zirconium and hafnium involving initial separation via SX, zirconium bisulphate (ZBS), zirconium oxychloride (ZOC) and zirconia production, and additional SX treatment to produce separated, high purity zirconium and hafnium products.
- Recovery of Au and radioactivity control, from anode slimes for BHP's Olympic Dam Operation.
- Recovery of scandium from laterite deposits and as a by-product of rare earth processing. Work has been conducted on the initial processing through to production of high purity oxide.
- Recovery of vanadium via alkaline leaching-IX-redcake precipitation from uranium/vanadium (carnotite) ores, and the acid leaching and SX from refractory uranium/vanadium, and vanadium minerals.

These efforts have directly supported several NI 43-101 reports, preliminary and definitive feasibility studies, demonstration plant operation.

Various images of critical metals process development, continuous piloting and demonstration plants undertaken by ANSTO's Minerals business unit are presented in Appendix D.

Capability Statement – Minerals business unit

Radioactivity Control and Management

The management of naturally occurring radioactivity (NORM) is an important aspect of uranium and rare earth processing, however, this issue can also arise in copper and mineral sands processing, plus numerous other processing flowsheets. ANSTO has more than 45 years' experience in the handling of ores, concentrates and other metallurgical products in a diverse range of industries where radioactivity is present.

Our extensive experience in the management of NORM has allowed us the opportunity to develop unique processes for radionuclide removal and control. We can also provide advice on the international limits for radioactivity levels in tradeable commodities.

ANSTO also has extensive knowledge of local, national and international regulations with regard to radiation protection and in the trade, transport and import of mineral commodities containing NORM. This knowledge is continually updated to meet the requirements of our clients and is a consequence of our links with organisations such as ARPANSA and the IAEA.

ANSTO's Minerals business unit offers advice to industry on how to overcome problems arising from the presence of radioactivity in minerals. We offer the following services on a confidential basis:

- Determination of the concentrations of radionuclides;
- Understanding the health and safety implications of the presence of radioactivity;
- Knowledge of state, national and international legislation regarding the handling of mineral products containing radioactivity;
- Physical and chemical treatment processes to remove radioactivity;
- Treatment and management of radioactive wastes; and

Laboratory and pilot plant test work / studies.

Images of ANSTO's in-house radioanalytical facilities are presented in Appendix E. Currently, ANSTO operates ten (10) high resolution gamma spectrometers as part of its normal business. Additional measurement capacity is possible if required.

Novel Flowsheet Design, Process Modelling and Scoping Level Engineering

Our specialist knowledge in flowsheet design allows us to provide tailored solutions in defining and optimising hydrometallurgical processes. ANSTO has a proven track record of applying our expertise to challenging ores with complex mineralogy and to multi-commodity resources.

ANSTO undertakes its process development work often supported by generation of process models prepared using Ideas™ and other modelling packages. The models include a mass and energy balance around the major sections of the circuit, and include data obtained from the literature or other sources, and data generated in the associated test work programs. The model is used to assess the impact of varying process conditions on circuit performance, and to define the variables to be investigated in subsequent test work phases.

Capability Statement – Minerals business unit

We have developed in-house expertise and packages to model SX and IX circuit performance, and to design circuits for continuous piloting and demonstration plant operation.

ANSTO has undertaken numerous scoping level engineering / cost estimate studies for uranium, rare earth, lithium and other flowsheets, where estimates are based on preliminary data, test work, and engineering design. Typically, factored estimates for CAPEX and OPEX at +50% are provided, which incorporate key design inputs from test work outcomes and a factored estimate based upon the selection of major equipment. The following is an outline of the major deliverables from this level of study:

- i. Outline process description
- ii. Process flow diagrams (PFD)
- iii. Preliminary process mass balance for major elements (excluding heat balance although heating requirements are estimated for the calculation of OPEX)
- iv. Preliminary Process Engineering including
 - a. major process assumptions
 - b. reagent consumptions
 - c. major equipment list
 - d. assumed manpower requirements.
- v. A preliminary assessment of waste liquors treatment options is included. Residue waste disposal options can be considered if included in the scope
- vi. CAPEX and OPEX at +/- 30% accuracy based upon above assessments.

Pilot Plant Data Analysis – Specific Details

In support of continuous pilot trials and demonstration plant operation, ANSTO has developed an Excel based data analysis package to ensure that decision making is based on the latest results. The package is fully tailorable to our client's needs and brings together all the associated analytical, laboratory and operational data into one file. The outputs from this package include the following:

- Daily summary tables and trending of key parameters and operating conditions
- Automated trending tools with added features (e.g. zoom functionality on axes)
- Automated data summaries with adjustable time periods
- Data output in the format of a process flow diagram (per unit process) to aide interpretation and to support the operational change decision-making process.

Various outputs from this package are presented in Appendix F.

In-House Analysis – Specific details

ANSTO has a suite of in-house analytical instruments that can be operated as needed in order to meet project requirements. This includes 24/7 coverage during pilot plant trials. Our Analytical section contains the following instruments:

Capability Statement – Minerals business unit

- Scanning Electron Microscope (SEM) with EDS and QEMSCAN
- 2 x XRD – inactive and active
- 2 x ICP-OES
- 2 x ICP-MS
- 2 x XRF – energy dispersive and wavelength dispersive (MiniPAL)
- 1 x LECO
- 2 x Ion Selective Electrode setups – automated
- Thermal analysis – TGA-DSC
- Rheology – stress / strain

Various images of ANSTO's analytical facilities are presented in Appendix G.

Solvent Extraction – Specific details

While ANSTO has developed world-class expertise in rare earth separation using SX, our expertise has also been applied across a wide range of other areas, including:

- Development of a unique SX circuit for the recovery and purification of cerium from a sulphate feed, which differs from conventional rare earth SX, which treats chloride or nitrate feeds
- Mini pilot plant testing of the cobalt and nickel SX circuits for a nickel laterite project
- Development of processes for impurity removal and support for technical difficulties experienced in the uranium/copper leaching and SX circuits at an operating site
- Development of a patented SX process for the recovery of gold, and rejection of radionuclides, from anode slimes produced in copper electrowinning circuits
- Development and continuous testing of an alternative process to recover uranium from sulphate leach liquors containing high chloride levels (equivalent to sea water)
- Development and continuous testing of SX processes to recover high purity zirconium and hafnium from sulphate-based process streams
- Desktop evaluation of proposed process flowsheets involving SX for the recovery of rare earths, scandium and titanium.

Various images of ANSTO's SX facilities are presented in Appendix H.

Capability Statement – Minerals business unit

APPENDIX A

Uranium Processing – Process Development, Continuous Piloting and Demonstration Plant Images



Figure A1 IX rig designed / built by ANSTO installed on site

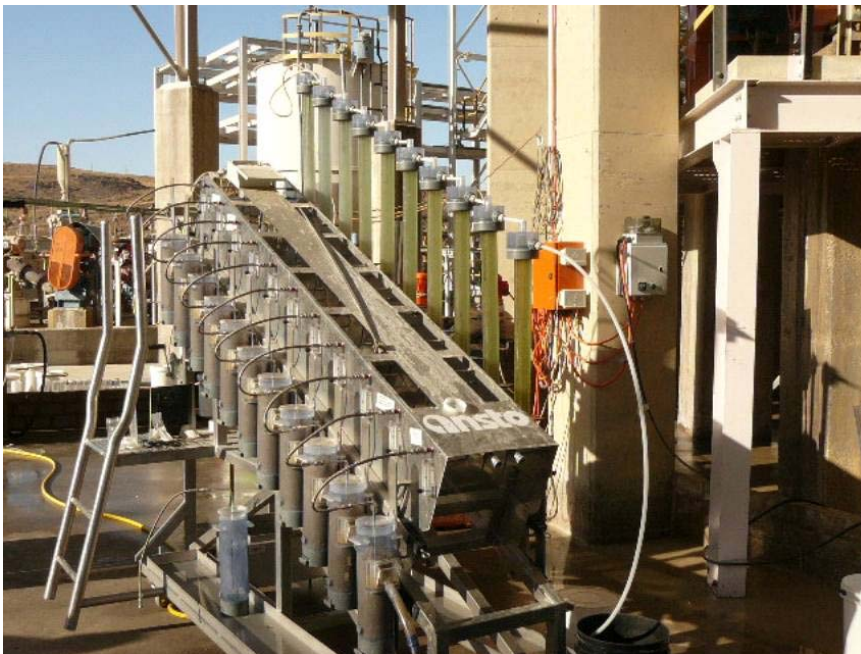

Figure A2 Combined RIP and fixed bed IX rig designed / built by ANSTO installed on site

Capability Statement – Minerals business unit



Figure A3 Fixed bed IX rig designed / built by ANSTO installed at ANSTO



Figure A4 Uranium leach circuit – pH controlled acid leach at ANSTO

Capability Statement – Minerals business unit



Figure A5 Modern, purpose-built laboratory for leaching process development test work – ANSTO

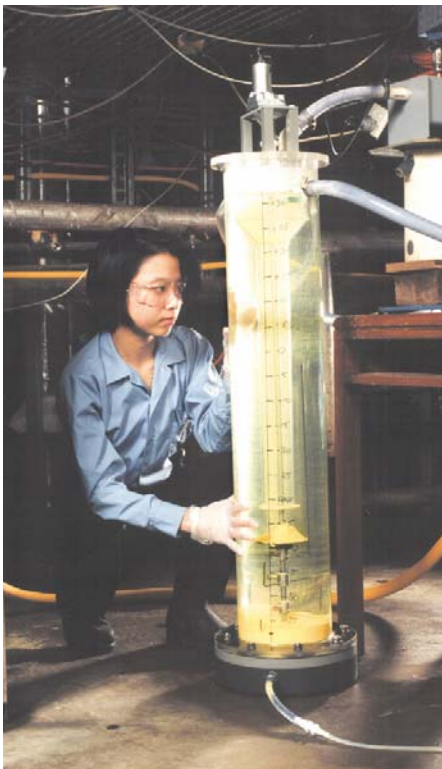

Figure A6 SDU Precipitation test rig at ANSTO

Capability Statement – Minerals business unit



Figure A7 Heap leach column test rig (2 m) designed / built by and installed at ANSTO. 4 m variants also available.

Capability Statement – Minerals business unit



Figure A8 Nanofiltration continuous pilot rig installed at ANSTO



Figure A9 Ore sorter pilot plant trial managed and operated by ANSTO on site

Capability Statement – Minerals business unit

APPENDIX B

Rare Earths – Process Development, Continuous Piloting and Demonstration Plant Images



Figure B1 Rare earths leach circuit – pH controlled acid leach – at ANSTO



Figure B2 Mixed rare earths carbonate precipitation circuit at ANSTO

Capability Statement – Minerals business unit



Figure B3 Softening circuit for water recycle at ANSTO



Figure B4 Twin-shaft pug mixer testing for acid / ore mixing / feeding at ANSTO

Capability Statement – Minerals business unit



Figure B5 Fluidised bed testing for acid / ore drying / agglomeration on site

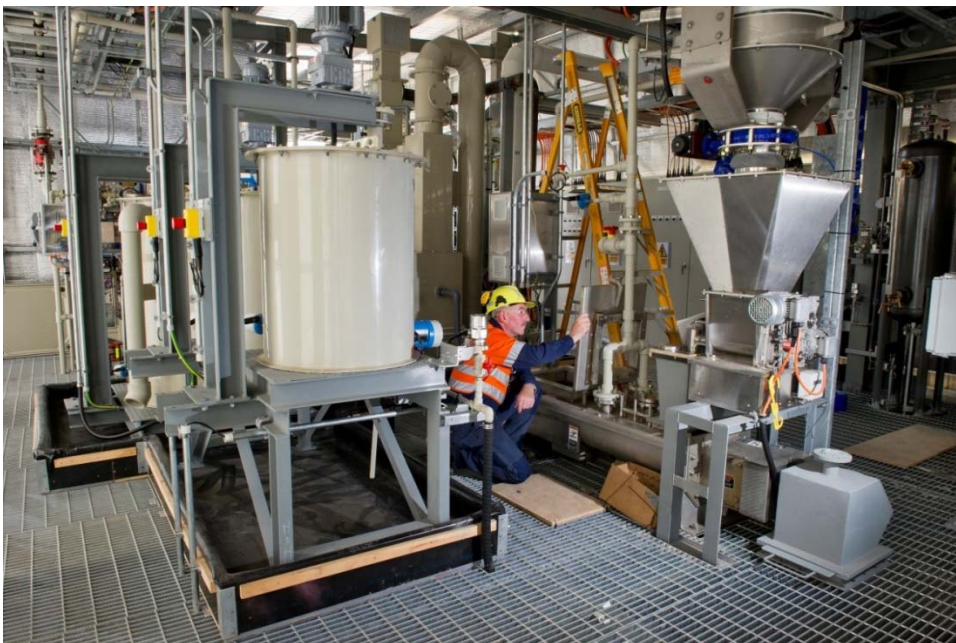

Figure B6 IBS twin-shaft mixer and automatic feed system installed at ANSTO

Capability Statement – Minerals business unit



Figure B7 Kilns for sulphation roasting as part of RE processing – throughput rates ranging from 100s' kg/h (top left), to 10s' kg/h (top right), to ~2 kg/h (bottom right), and <1 kg/h (bottom right) – installed at ANSTO

Capability Statement – Minerals business unit

APPENDIX C

Lithium – Process Development, Continuous Piloting and Demonstration Plant Images



Figure C1 Lithium ore leach circuit at ANSTO



Figure C2 Evaporation and Ca / Mg IX circuits at ANSTO. Up to 20 L/h per unit

Capability Statement – Minerals business unit



Figure C3 Softening circuit for lithium processing at ANSTO



Figure C4 Lithium carbonate precipitation circuit at ANSTO

Capability Statement – Minerals business unit



Figure C5 Lithium sulphate crystalliser – ~2 kg per batch – semi-continuous



Figure C6 Lithium carbonate chemical concentrate production at ANSTO

Capability Statement – Minerals business unit



Figure C7 Brine processing demonstration plant at ANSTO – overall



Figure C8 Brine processing demonstration plant at ANSTO –ion-exchange circuit

Capability Statement – Minerals business unit



Figure C9 Brine processing demonstration plant at ANSTO – impurity removal circuit



Figure C10 Brine processing demonstration plant at ANSTO – Andritz belt filter ancillary components

Capability Statement – Minerals business unit

APPENDIX D

Speciality Metals – Process Development, Continuous Piloting and Demonstration Plant Images



Figure D1 Example of autoclave equipment at ANSTO – high pressure acid leach (HPAL), pressure oxidative leach (POX) and caustic conversion – up to 2 L scale, number of materials of construction options



Figure D2 Demonstration plant for Toongi / Dubbo project for recovery of zirconium, niobium, hafnium and rare earths

Capability Statement – Minerals business unit



Figure D3 Ferro-niobium production - ~200 g button scale



Figure D4 High density sludge (HDS) circuit and high rate thickener designed / built by ANSTO installed on site

Capability Statement – Minerals business unit

APPENDIX E

Radioanalytical Facilities – Description and Images

Specialised knowledge in the processing of ores containing naturally occurring radioactivity requires a range of facilities and capabilities, including:

Gamma Spectrometry

The activities of radionuclides in the ^{238}U and ^{232}Th decay chains are determined by gamma spectrometry. A decay chain is said to be in secular equilibrium if the measured activity concentrations (Bq/kg of solid) of the decay chain radionuclides are statistically the same ($\pm 10\%$).

Delayed Neutron Counting (DNA) and Neutron Activation Analysis (NAA)

Uranium and thorium concentrations are measured using the OPAL reactor on site at ANSTO using DNA and NAA, respectively. Both are selective, sensitive and rapid nuclear techniques used to determine ^{238}U and ^{232}Th at ppm levels or lower and are the most accurate methods for determining these elements.

Radiochemistry

Polonium-210 is not a gamma emitter and is determined using radioanalytical chemistry. Polonium-210 is selectively extracted and counted using alpha spectrometry.



Figure E1 Extensive gamma spectrometry and alpha counting facilities at ANSTO

Capability Statement – Minerals business unit

APPENDIX F

Operational and Data Analysis Package – Continuous Piloting and Demonstration Plant Operation

Date: 24/08/2017 Process: WL Op. Period: 1 Start: 24/08/17 06:00 End: 24/08/17 18:00						
Phase 2 - Water Leach - Process Conditions						
Stream ID	Description	Variable	Units	Target	Average	Comments
201	WL Calcine Feed	Total Flow	kg/h	4.00	4.20	
202	WL H2SO4 Dosing	Total Flow	kg/h	0.25	0.30	
203	WL Water Dosing	Total Flow	kg/h	24.00	25.20	
208	WL Tank 5 (TNK208)	Total Flow	kg/h	32.00	31.00	
204	WL Tank 1 (TNK204)	Temp.	°C	50.0	51.2	
205	WL Tank 2 (TNK205)	Temp.	°C	50.0	51.1	
206	WL Tank 3 (TNK206)	Temp.	°C	50.0	50.0	
207	WL Tank 4 (TNK207)	Temp.	°C	50.0	49.6	
208	WL Tank 5 (TNK208)	Temp.	°C	50.0	45.0	
204	WL Tank 1 (TNK204)	pH (slurry)	-	1.00	1.50	
205	WL Tank 2 (TNK205)	pH (slurry)	-	1.00	1.40	
206	WL Tank 3 (TNK206)	pH (slurry)	-	1.00	1.30	
207	WL Tank 4 (TNK207)	pH (slurry)	-	1.00	1.10	
208	WL Tank 5 (TNK208)	pH (slurry)	-	1.00	1.00	
204	WL Tank 1 (TNK204)	ORP (slurry)	mV	500	480	
205	WL Tank 2 (TNK205)	ORP (slurry)	mV	500	472	
206	WL Tank 3 (TNK206)	ORP (slurry)	mV	500	499	
207	WL Tank 4 (TNK207)	ORP (slurry)	mV	500	501	
208	WL Tank 5 (TNK208)	ORP (slurry)	mV	500	509	
212	WL Thickener U/F	SG (slurry)	-	1.10	1.20	

Figure F1 Example of Daily Summary Table – Key Parameters

Phase 2 - Water Leach - Elemental Department								
Element	WL Calcine Feed	WL Filtrate	WL Filtrate	WL Filter	% Department	% Department	Accountability [in/out] (%)	%Dissolution
	XRF (wt%)	ICPOES (mg/L)	ICPOES (mg/L)	XRF (wt%)	(Solids Product)	(Liquid Product)		
Al	1.5	1,500	1,435	0.1	6	87	93	91.1
Ba	1.7	-	-	9.8	17	87	104	0.0
Ca	3.2	954	1,200	12	4	90	94	25.1
Ce	4.1	6,320	4,900	0.22	30	82	112	94.3
Cr	0.4	120	300	0.1	40	55	95	87.4
Cl	-	-	-	-	5	91	96	-
F	-	-	-	-	4	99	103	-
Fe	5	8,020	7,700	2.3	35	67	102	92.8
K	0.6	50	80	0.27	9	95	104	59.5
La	2.4	1,500	1,500	0.09	17	95	112	94.2
Mg	0.1	359	250	0.6	6	101	107	98.1
Mn	0.4	600	499	0.35	7	86	93	93.4
Na	0.09	60	30	0.21	23	74	97	32.8
Nd	5.9	6,890	5,643	1.2	8	89	97	93.6
P	2.5	3,500	4,555	2.15	14	80	94	82.6
Pr	0.4	1,500	870	0.67	33	61	94	94.0
S	17	29,300	16,590	12.5	32	60	92	89.5
Sc	-	-	-	-	4	91	95	-
Si	1	9,540	550	3.1	36	56	92	43.8
Sm	0.42	420	320	0.09	7	84	91	90.9

Figure F2 Example of Daily Summary Table – Elemental Department

Capability Statement – Minerals business unit

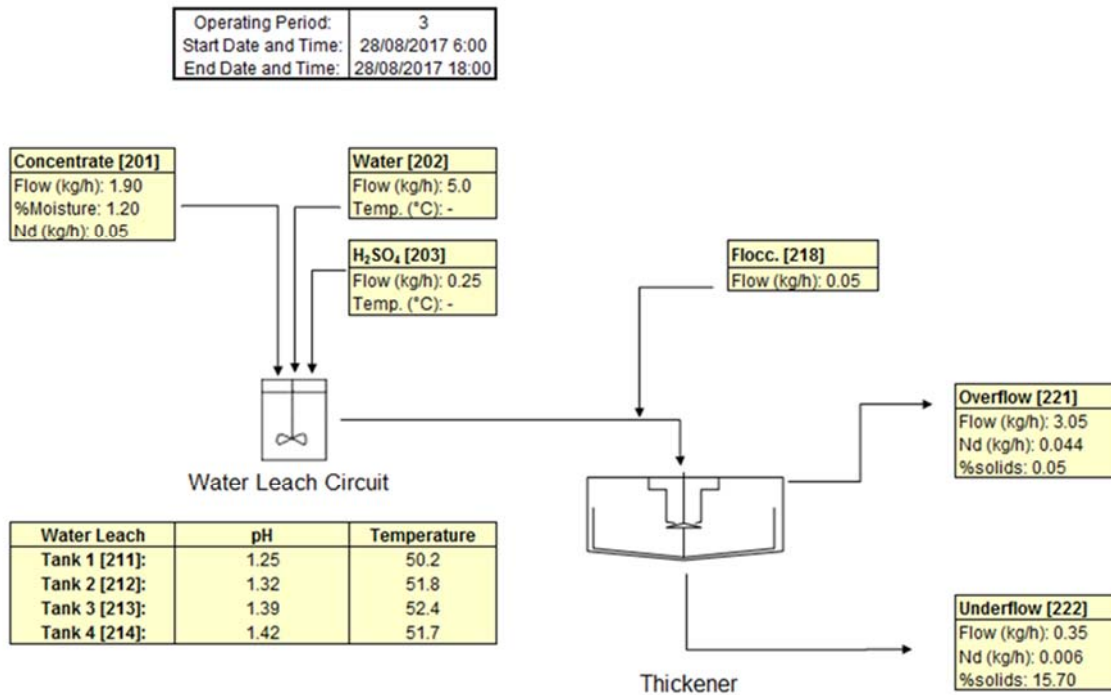

Figure F3 Example of Daily Summary – PFD Format

Capability Statement – Minerals business unit

APPENDIX G

Analysis – In-House Analytical Facilities Images

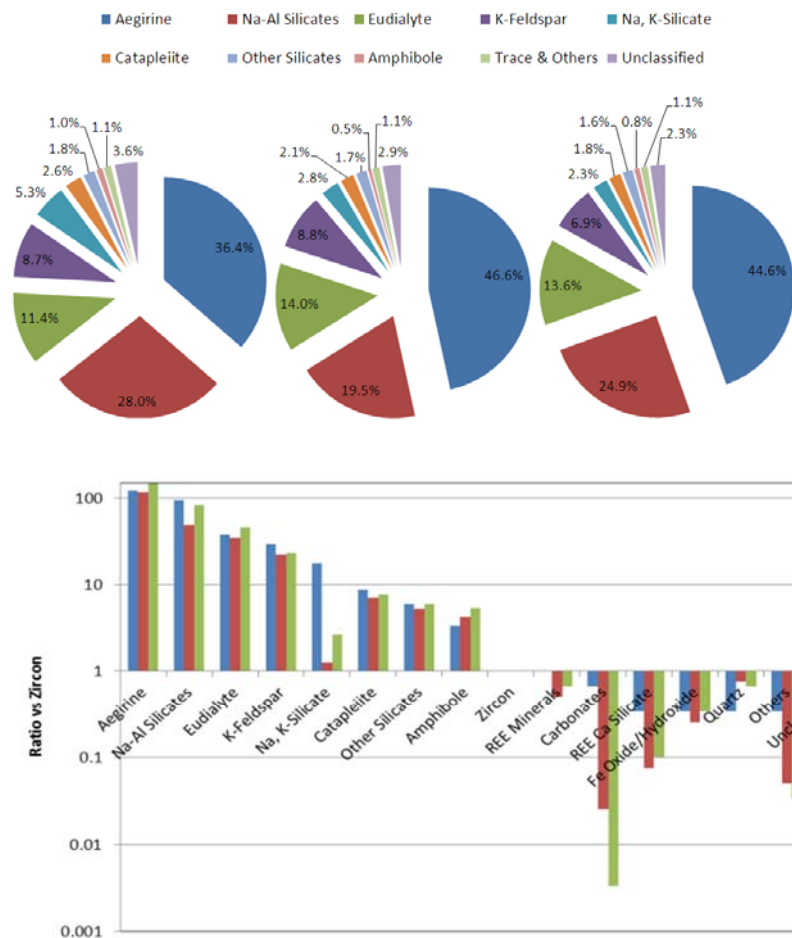

Figure G1 Mineralogy facilities at ANSTO – QEMSCAN / SEM

Capability Statement – Minerals business unit



Figure G2 X-Ray Fluorescence (XRF) plus bench-top mini-PAL



Figure G3 Inductively Coupled Plasma Optical Emission and Mass Spectrometers (ICP-OES x 2 and ICP-MS x 2)

Capability Statement – Minerals business unit



Figure G4 Supporting equipment for fusion and fusion-digest sample preparation

Capability Statement – Minerals business unit

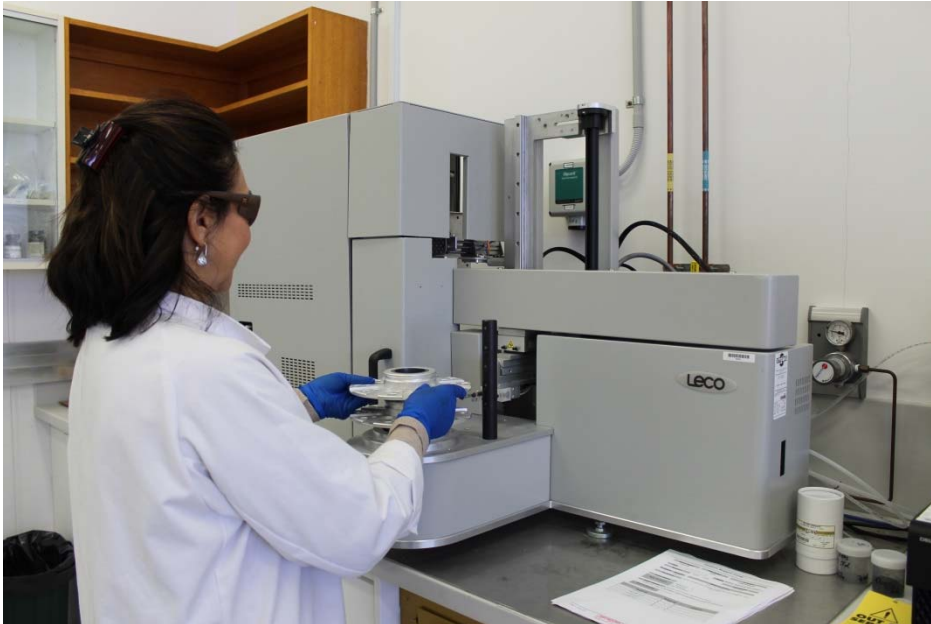

Figure G5 Inorganic and organic carbon and sulfur by LECO

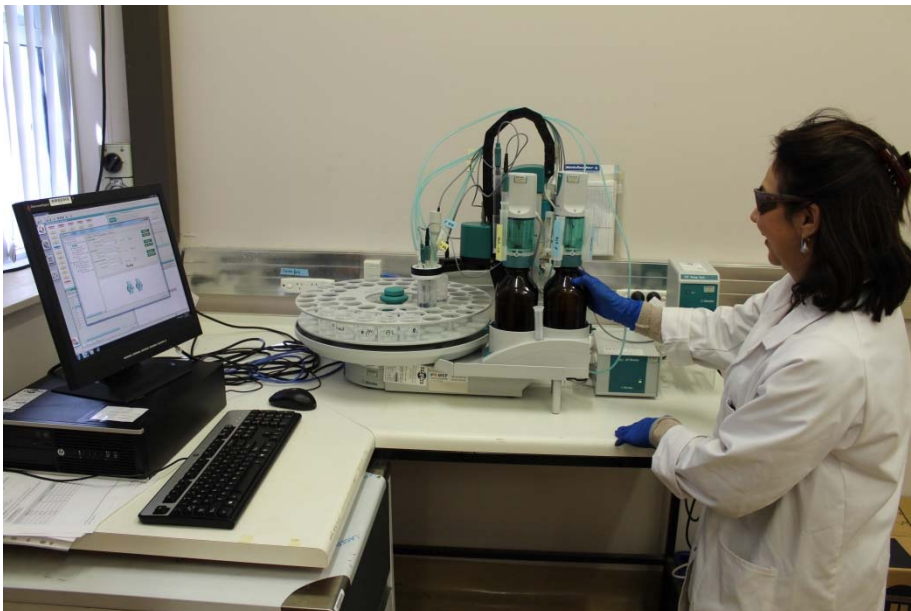

Figure G6 Ion Selective Electrode (ISE) for F and Cl

Capability Statement – Minerals business unit



Figure G6 Thermogravimetric Analysis and Differential Scanning Calorimetry (TGA-DSC)

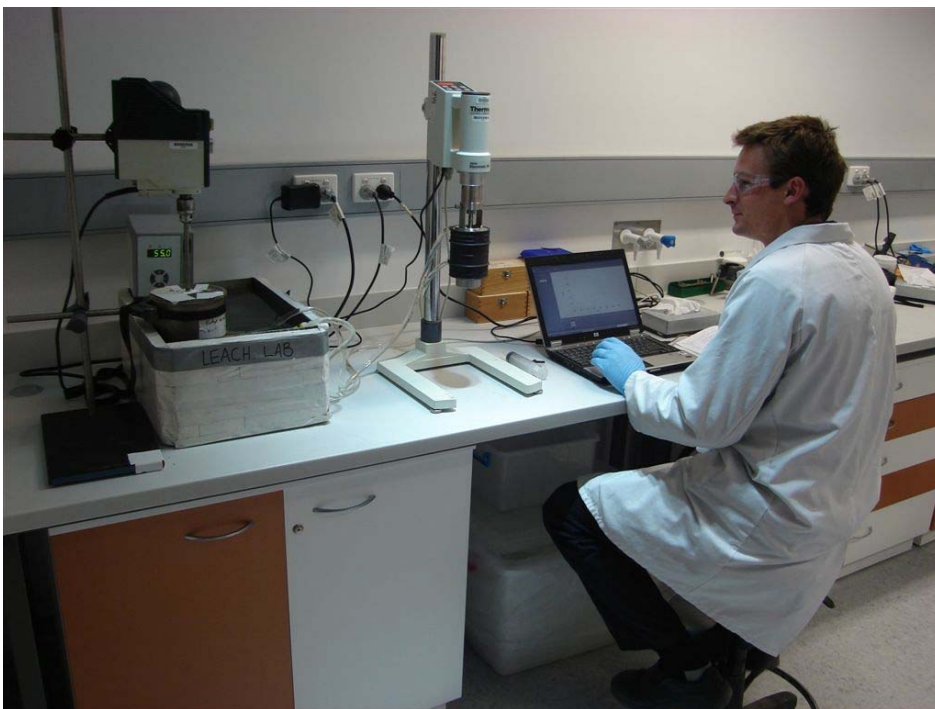

Figure G7 Rheology equipment available to support Process Development and continuous piloting programs

Capability Statement – Minerals business unit

APPENDIX H

Solvent Extraction Facilities – Various Images



Figure H1 State-of-the-art SX mini-plant pilot facilities for small scale, continuous testing – modular design for limitless circuit configurations at ANSTO

Capability Statement – Minerals business unit



Figure H2 SX demonstration plant designed / built by ANSTO for zirconium at ANSTO



Figure H3 Pulsed column demonstration plant designed / built by ANSTO for uranium at ANSTO

Capability Statement – Minerals business unit

APPENDIX I

Key Staff Biographies

Robert Gee – General Manager

Dr Rob Gee is the General Manager of the ANSTO's Minerals business unit. He is responsible for the overall management of the Minerals team and the delivery of client programs. Rob provides support to current operations as well as the delivery of pre-feasibility and feasibility study inputs including pilot plant testing programs. During his time with ANSTO, Rob has been responsible for a range of projects involving different metals such as: copper, uranium, rare earths and lithium.

Rob joined ANSTO in 2013 and has over 25 years' experience in the extractive metallurgy and chemicals fields. Rob has extensive experience working in technology development and implementation within both large and small corporations and as a consultant to the mining, minerals and metals industry. His technical expertise includes hydrometallurgical processing with a focus on uranium, copper, manganese, lithium and rare earths and the economics of their production.

Additionally, Rob has experience in general management and business development developed during roles with companies such as BHP Billiton and Delta EMD and his time as an independent consultant.



Dr Karin Soldenhoff – Technology Manager

Dr Karin Soldenhoff is the Technology Manager within the ANSTO's Minerals business unit, leading the process development and research groups. In her current role, she provides oversight and broad technical direction for research projects and commercially sponsored projects in the area of hydrometallurgical process development of interest to ANSTO, with special emphasis in separation technologies.

Karin has worked at ANSTO since 1990 in various technical roles and has held a senior managerial role in the ANSTO's Minerals business unit since its inception in 2004.

Prior to joining ANSTO Karin was employed by the Council for Mineral Technology (South Africa) between 1984 and 1988 and by Southern Cross Mining in Ghana, West Africa (1989).

Over a 30 year career in process development for the mining industry, Karin has led numerous projects regarding various aspects of hydrometallurgical processing of uranium, rare earths, base metals, precious metals and other speciality metals such as vanadium, zirconium, hafnium, niobium and lithium. Following her involvement in both industry commissioned and research projects, Karin has been the author and significant co-author on numerous industry publications including, 180 technical commercial-in-confidence reports, 19 publications in scientific journals and patent literature, over 40 conference paper and presentations at industry meetings.



Capability Statement – Minerals business unit

Her specific research interests include, the development of alternative ion exchange technology for the recovery of uranium from phosphoric acid, the development of solvent extraction and ion exchange technology for uranium recovery from highly saline solutions, novel separation technologies for rare earths, solvent extraction technology for zirconium and hafnium separation, and the development of novel separation processes for copper anode slimes based on chloride hydrometallurgy.

Bob Ring – Technical Consultant

Bob Ring is a Technical Consultant within the ANSTO's Minerals business unit, specialising in uranium and hydrometallurgical processing

Bob has authored more than 200 reports for industry and has a wealth of knowledge and experience having been closely involved in all of Australia's uranium production operations since 1978. He has also contributed his expertise to numerous international uranium projects located in Namibia, Malawi, Tanzania, Mali, South Africa, Botswana, Zambia, Mauritania, Sweden, and the former East German operations of WISMUT. Bob has also led process development studies for most of Australia's prospective uranium projects.

Bob has close to 40 years' experience in R&D and consultancy work for clients in Australia and overseas related to the hydrometallurgical processing of ores. Particular areas of expertise are the leaching of uranium ores, water treatment and recycle in uranium flowsheets, and the deportment of radionuclides in hydrometallurgical circuits. He has undertaken a number of collaborative projects with the mining industry, and acted as a consultant to the International Atomic Energy Agency in uranium processing.



Adrian Manis – Pilot Plant Manager

Adrian Manis is the Manager, Pilot Plant Operations within the ANSTO's Minerals business unit. His role focusses on the scale up of hydrometallurgical processes from batch to continuous testing, from miniature through to demonstration pilot plant scale.

Having joined ANSTO's Minerals business unit in 2001, Adrian has worked on a range of projects covering rare earths, niobium and zirconium, uranium, lithium, base metals (nickel/copper) and titanium.

His areas of expertise include pilot plant design, sulphation roasting, membrane applications, precipitation processes using high density sludge (HDS) and the assessment and management of naturally occurring radioactive materials (NORM) in metallurgical processes.

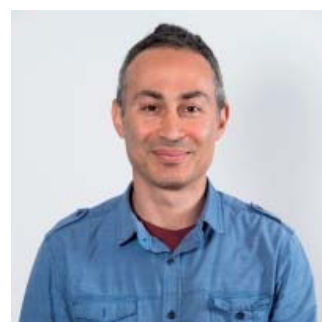

Capability Statement – Minerals business unit

Paul Freeman – Manager Uranium

Paul Freeman is the Manager, Uranium within the ANSTO's Minerals business unit. Paul manages a group of 15 professionals and technicians responsible for small scale test work and pilot testing in uranium and other metals. His role encompasses all project phases from identifying areas for improvement, client liaison and scoping, through to project completion with detailed reporting.

Paul has been involved in numerous commercial projects including, Rincon Lithium, Serra Verde rare earths, the Falea silver, copper and uranium deposit, and several BHP uranium and copper projects.

Paul has previous experience in engineering companies and consultancy roles, giving him experience in techno-economic projects and management of large scale pilot campaigns. He joined ANSTO in 2011. With nearly 40 years' experience in the minerals industry, Paul has experience in project management, evaluation, process flow sheet design, development and plant commissioning. He has been involved in the management, production and review of plant models, process design and the design, construction, commissioning and operation of pilot and full scale plants.

He also has extensive knowledge of extractive metallurgy for nickel, uranium, copper, cobalt, zinc, gold, iron and silica as well as valuable experience in metallurgical and financial modelling, automated process control, metallurgical test work and problem solving.

Paul is the process inventor and co-inventor of numerous patents including processes for uranium, nickel, copper, zinc and lead and he has published papers on zinc processing.

He has broad knowledge of a range of operating sites both in Australia and overseas including, Botswana Metals Refinery Hydrometallurgical Demonstration Plant (nickel, copper and cobalt refinery) Cawse Nickel Refinery, Port Pirie and Cockle Creek (lead and zinc smelters) Hobart, Budel Zinc, and Clarksville (zinc refineries) Elura, Century and Rosebery (lead and zinc concentrators) Vaal Reefs – South Africa (gold plants x 5, uranium plants x 3). Overseas exposure includes working in Britain and South Africa as well as secondments to Botswana, The Netherlands and USA.



Dr Chris Griffith – Senior Process Chemist / Business Development Lead

Dr Chris Griffith is the Business Development Lead within the ANSTO's Minerals business unit. He is responsible for marketing the capabilities of ANSTO and developing repeat and new business opportunities for the group. Prior to taking this position he was the groups Senior Process Chemist, a role encompassing a wide range of activities including desktop assessment of prospective projects, mineralogy, beneficiation, flowsheet selection and definition, radioactivity department/management and continuous piloting for demonstration and design purposes.



Chris has extensive experience in rare earth, lithium and speciality metals processing, encompassing all aspects of a wide variety of hydrometallurgical flowsheets from ore / mineral concentrate to intermediate chemical concentrates to high purity finished

Capability Statement – Minerals business unit

products. Of particular note is his development and / or contribution to the development of novel flowsheets to realise the value from undervalued ores.

Complementing this process expertise is experience with the application of speciation modelling to better understand the fundamentals behind deportment of valuable elements of interest through complex hydrometallurgical flowsheets.

Chris also has a keen interest in the deportment of naturally occurring radioactivity through complex hydrometallurgical flowsheets, and progressing flowsheet development from batch to continuous operation.

Chris initially took up a position at ANSTO working on the development of novel hydrometallurgical and pyrometallurgical separation technologies applicable to current and advanced nuclear fuel cycles. Chris took the opportunity to join ANSTO's Minerals business unit in 2008 to broaden his process development skills in a more wide-reaching industrial context, which spans a number of strategic and technologically important commodities and in this time has also made a large contribution to the process development efforts on numerous projects for the extraction of rare earths, lithium, zirconium, and niobium.

Over a 16 year career, Chris has been involved in research in the nuclear industry and process development for the mining industry undertaking numerous projects for ANSTO in collaboration with various international organisations (e.g. US DOE, EU) and for industrial clients on a contract research basis.

Through this work, Chris has authored and co-authored approximately 135 technical commercial-in-confidence reports, 35 scientific publications, 2 patents and numerous conference presentations.

Dr Marina Fainerman-Melnikova

Dr Marina Fainerman-Melnikova is a Senior Chemist in the Process Development Research group of ANSTO's Minerals business unit. She is responsible for running projects focused on developing hydrometallurgical processes for rare earth separation and uranium purification and recovery.

Marina has over ten years' experience in rare earth research and commercial projects. She specialises in rare earth and uranium solvent extraction and ion exchange, and is involved in the running of numerous solvent extraction pilot plants.

After acquiring her PhD, Marina worked as Post-Doctoral Research Associate at the University of Sydney, focusing on chemistry of macrocycles (synthesis, characterisation of metal complexes and metal ion recognition studies).

Marina joined ANSTO's Minerals business unit as Post-Doctoral Fellow in 2007, conducting the research in the area of application of ion exchange for uranium recovery from saline solutions.



Capability Statement – Minerals business unit

Dr Mark Maley

Dr Mark Maley is a Senior Hydrometallurgist within ANSTO's Minerals business unit. He is responsible for leading projects related to uranium leaching and flowsheet development, as well as the hydrometallurgical processing of ores containing naturally occurring radioactive material,

Prior to joining ANSTO's Minerals business unit in 2009, he held roles in BHP Billiton Technology and CSIRO Minerals and has worked on projects for a number of established and emerging mining companies based throughout Australia, Canada and Africa. In addition to uranium, Mark has extensive experience in the hydrometallurgical processing of base metal ores, having previously been employed in the process development for copper and nickel sulphides, as well as nickel laterites. He has a particular interest in biohydrometallurgy, having completed his doctoral studies in this area and subsequently been involved in projects relating to bacterial heap leaching of base metal sulphides.



Tomasz Safinski

Tomasz is a member of Process Development and Research Group in ANSTO's Minerals business unit and has been with ANSTO since 2007.

As project leader on various commercial projects, Tomasz has worked on scale-up of test work and operation of pilot plants involving ion exchange and solvent extraction. Tomasz has organised test work, designed rigs and managed campaigns for the development of the PhosEnergy process, for extraction of uranium from phosphoric acid by ion exchange. Tomasz has also conducted test work programs relating to the impact of silica on ion exchange and investigated the impact of silica on operation of RIP circuits.

Tomasz designed pulsed column pilot and demonstration plant rigs for the purpose of comparison studies with mixer settler circuits for strategic metals separation. Tomasz organised and supervised the optimisation and operation of these rigs, which were operated as part of wider piloting campaigns. In total 2 studies and 2 pilot plants were conducted.

Tomasz has contributed as campaign manager to the design, installation and operation of various pilot plants for the development of hydrometallurgical processes. These included piloting of 3 different rare earth flowsheets for separate clients, strategic metals recovery by two stage acid leaching, piloting the recovery of zinc, using a two stage precipitation process, waste water treatment pilot plants including high density sludge neutralisation and chemical softening.

Tomasz has conducted preliminary and scoping Capex/Opex studies for assessment of a number of rare earth projects.

Capability Statement – Minerals business unit

Maritza Valencia Bejarano

Maritza is a Senior Process Engineer with 13 years' experience in hydrometallurgical process development from proof of concept, test work through to demonstration plant commissioning and operations. Maritza graduated from the University of Valle (Colombia) with a Bachelor of Engineering- Chemical, and completed a Masters of Engineering Research at the University of Sydney. Maritza joined ANSTO's Minerals business unit in 2015 as part of the Pilot Plant Group.



Maritza's responsibilities include compilation of process design criteria, development of PFDs, P&IDs, mass and energy balances, equipment sizing, and preparation of capital and operating cost estimates for engineering scoping studies.

At ANSTO, Maritza has been involved in the development of engineering costs studies for opportunity assessment for rare earths metals. Maritza has also worked on the process flowsheet development and pilot plant operation for the production of lithium carbonate from brine.

Dr Suzanne Burling

Dr Suzanne is a Senior Hydrometallurgist in the Uranium Processing Group of ANSTO's Minerals business unit and has been with ANSTO since 2009. She is primarily responsible for managing uranium leach projects, working closely with our clients to coordinate test programs.



Suzanne specialises in the processing of ores containing uranium. Her primary expertise is in the development of uranium projects including variability and optimisation leach programs, fundamental uranium leach studies, radionuclide department and removal from concentrates, and uranium heap leaching.

Prior to joining ANSTO in 2009, Suzanne worked for BHP Billiton at the Newcastle Technology Centre as a Senior Chemist.